

# Superior pressure transmitter for general industrial applications Model S-20

WIKA data sheet PE 81.61

## Applications

- Critical industrial applications
- Demanding applications in research and development
- Harsh environments in the process industry

## Special features

- Measuring ranges from 0 ... 0.4 to 0 ... 1,600 bar
- Non-linearity of up to 0.125 % of span
- Different output signals, e.g. 4 ... 20 mA, DC 0 ... 10 V, DC 1 ... 5 V and others
- Market-standard electrical connections, e.g. DIN 175301-803 A angular connector
- Common international process connections



Pressure transmitter model S-20

## Description

The model S-20 pressure transmitter for general industrial applications is the ideal solution for customers with demanding measuring requirements. It features a very good accuracy, a robust design and an exceptional number of variants, meaning it can be suited to the widest range of applications.

### Versatile

The model S-20 offers continuous measuring ranges between 0 ... 0.4 and 0 ... 1,600 bar in all the major units. These measuring ranges can be combined in almost any way with all the standard industry output signals, the most common international process connections and a wide number of electrical connections.

Furthermore, it offers numerous options, such as different accuracy classes, extended temperature ranges and customer-specific pin assignments.

### High quality

The robust design turns the model S-20 into a very high quality product, which even the most adverse environmental conditions cannot affect. Whether with the lowest temperatures when used outdoors, with extreme shock and vibration in machine building or with aggressive media in the chemical industry, this transmitter can meet all requirements.

### Availability

All variants described in this data sheet are available on very short lead times. For particularly urgent demands, there is a sizeable stock available.

## Measuring ranges

Relative pressure							
bar	0 ... 0.4	0 ... 0.6	0 ... 1	0 ... 1.6	0 ... 2.5	0 ... 4	0 ... 6
	0 ... 10	0 ... 16	0 ... 25	0 ... 40	0 ... 60	0 ... 100	0 ... 160
	0 ... 250	0 ... 400	0 ... 600	0 ... 1,000	0 ... 1,600		
psi	0 ... 10	0 ... 15	0 ... 25	0 ... 30	0 ... 50	0 ... 60	0 ... 100
	0 ... 150	0 ... 160	0 ... 200	0 ... 250	0 ... 300	0 ... 400	0 ... 500
	0 ... 600	0 ... 750	0 ... 1,000	0 ... 1,500	0 ... 2,000	0 ... 3,000	0 ... 4,000
	0 ... 5,000	0 ... 6,000	0 ... 7,500	0 ... 10,000	0 ... 15,000	0 ... 20,000	

Absolute pressure							
bar	0 ... 0.4	0 ... 0.6	0 ... 1	0 ... 1.6	0 ... 2.5	0 ... 4	0 ... 6
	0 ... 10	0 ... 16	0 ... 25	0 ... 40			
psi	0 ... 10	0 ... 15	0 ... 25	0 ... 30	0 ... 50	0 ... 60	0 ... 100
	0 ... 150	0 ... 160	0 ... 200	0 ... 250	0 ... 300	0 ... 400	0 ... 500

Vacuum and +/- measuring range							
bar	-0.4 ... 0	-0.6 ... 0	-1 ... 0	-1 ... +0.6	-1 ... +1.5		
	-1 ... +3	-1 ... +5	-1 ... +9	-1 ... +15	-1 ... +24		
	-1 ... +39	-1 ... +59					
psi	-30 inHg ... 0	-30 inHg ... +15	-30 inHg ... +30	-30 inHg ... +45	-30 inHg ... +60		
	-30 inHg ... +100	-30 inHg ... +160	-30 inHg ... +200	-30 inHg ... +300	-30 inHg ... +500		

The given measuring ranges are also available in kg/cm<sup>2</sup>, kPa and MPa.

Special measuring ranges between 0 ... 0.4 and 0 ... 1,600 bar are available on request.

Special measuring ranges have a reduced long-term stability and increased temperature errors.

### Overpressure limit

The overpressure limit is based on the sensor element used. Depending on the selected process connection and sealing, restrictions in overpressure safety can result. A higher overpressure limit will result in a higher temperature error.

Measuring range < 10 bar/150 psi ≥ 10 bar/150 psi	
3 times (standard)	2 times <sup>1)</sup> (standard)
5 times	3 times <sup>2) 3)</sup>

1) Restriction: max. 60 bar/870 psi with absolute pressure

2) Only possible for relative pressure measuring ranges ≤ 400 bar or 5,800 psi

3) Only possible for absolute pressure measuring ranges < 16 bar or 220 psi

### Vacuum tightness

Yes

## Output signal

Signal type	Signal
Current (2-wire)	4 ... 20 mA 20 ... 4 mA
Voltage (3-wire)	DC 0 ... 10 V DC 0 ... 5 V DC 1 ... 5 V DC 0.5 ... 4.5 V DC 1 ... 6 V DC 10 ... 0 V
Ratiometric (3-wire)	DC 0.5 ... 4.5 V

Other output signals on request.

### Permissible load in $\Omega$

- Current output (2-wire):  $\leq (\text{power supply} - 7.5 \text{ V}) / 0.023 \text{ A}$   
 $\leq (\text{power supply} - 11.5 \text{ V}) / 0.023 \text{ A}$  (with optional settling time of 1 ms)
- Voltage output (3-wire):  $> \text{maximum output voltage} / 1 \text{ mA}$
- Ratiometric output (3-wire):  $> 4.5\text{k}$

### Signal limiting (option)

- 4 ... 20 mA: Zero point: 3.6 mA <sup>1)</sup>, 3.8 mA, 4.0 mA  
Full scale: 20 mA, 21.5 mA, 23 mA
- DC 0 ... 10 V: Full scale: DC 10 V, DC 11.5 V

1) Not possible in combination with zero point adjustment by the customer

## Voltage supply

### Power supply

Maximum power supply for cULus approval: DC 35 V (DC 32 V with heavy-duty connector)

- Current output (2-wire)
  - 4 ... 20 mA: DC 8 ... 36 V (DC 12 ... 36 V with optional settling time of 1 ms)
  - 20 ... 4 mA (inverted): DC 8 ... 36 V
- Voltage output (3-wire)
  - DC 0 ... 10 V: DC 12 ... 36 V
  - DC 0 ... 5 V: DC 8 ... 36 V
  - DC 1 ... 5 V: DC 8 ... 36 V
  - DC 0.5 ... 4.5 V: DC 8 ... 36 V
  - DC 1 ... 6 V: DC 9 ... 36 V
  - DC 10 ... 0 V: DC 12 ... 36 V
- Ratiometric output (3-wire):
  - DC 0.5 ... 4.5 V: DC 5 V  $\pm 10\%$

### Dissipation loss

- Current output (2-wire): 828 mW (22 mW/K derating of the dissipation loss with ambient temperatures  $\geq 100 \text{ }^\circ\text{C}$ )
- Voltage output (3-wire): 432 mW

### Current supply

- Current output (2-wire): Current signal, max. 25 mA
- Voltage output (3-wire): max. 12 mA

## Reference conditions (per IEC 61298-1)

### Temperature

15 ... 25 °C

### Atmospheric pressure

860 ... 1,060 mbar

### Humidity

45 ... 75 % relative

### Power supply

- DC 24 V
- DC 5 V with ratiometric output

### Mounting position

Calibrated in vertical mounting position with pressure connection facing downwards.

## Time response

Signal type	Settling time per IEC 62594		Signal damping
	Standard <sup>1)</sup>	Option 1 <sup>2) 3)</sup>	Option 2
Current (2-wire)	<b>3 ms</b>	1 ms	10, 50, 100, 500, 1,000, 5,000 ms
Voltage (3-wire)	<b>2 ms</b>	1 ms	10, 50, 100, 500, 1,000, 5,000 ms
Ratiometric (3-wire)	<b>2 ms</b>	1 ms	10, 50, 100, 500, 1,000, 5,000 ms

1) 3 dB limit frequency: 500 Hz

2) 3 dB limit frequency: 1,000 Hz

3) Alternative specifications for 4 ... 20 mA output signal:

Load:  $\leq (\text{power supply} - 11.5 \text{ V}) / 0.023 \text{ A}$

Power supply: DC 12 ... 36 V

### Switch-on time

150 ms

### Switch-on drift

5 s (60 s with optional zero point adjustment 0.1 %)

## Accuracy data

Non-linearity (per IEC 61298-2)		Accuracy at calibration temperature
BFSL	Terminal method	
<b>≤ ±0.5 % of span (standard)</b>	<b>≤ ±1.0 % of span</b>	<b>≤ ±1.0 % of span</b>
≤ ±0.25 % of span	≤ ±0.5 % of span	≤ ±0.5 % of span
≤ ±0.125 % of span <sup>1)</sup>	≤ ±0.25 % of span <sup>1)</sup>	≤ ±0.25 % of span <sup>1)</sup>

1) Restrictions for the non-linearity of 0.125 % BFSL or 0.25 % with terminal method:  
 Available output signals: 4 ...20 mA and DC 0 ... 10 V  
 Available measuring ranges: All measuring ranges specified in the data sheet  
 For further output signals or measuring ranges, please ask the manufacturer

Calibration temperature
<b>15 ... 25 °C (standard)</b>
4 °C ±5 °C
40 °C ±5 °C
60 °C ±5 °C
80 °C ±5 °C

Zero point adjustment
<b>≤ ±0.2 % of span, factory setting (standard)</b>
≤ ±0.1 % of span, factory setting <sup>1)</sup>
±10 % of span, in 0.05 % increments, customer setting <sup>2)</sup>

1) Restrictions for the zero point adjustment of 0.1 % (factory setting):  
 Available output signals: 4 ...20 mA and DC 0 ... 10 V  
 Available measuring ranges: All relative pressure measuring ranges specified in the data sheet. Not available in combination with the optional calibration temperature.  
 2) The customer zero point adjustment is not available for all variants of electrical connection, see "Electrical connections".

### Relationship to the mounting position

For measuring ranges < 1 bar/15 psi, an additional zero offset of up to 0.15 % applies

### Non-repeatability

≤ ±0.1 % of span

### Temperature hysteresis

0.1 % of span at > 80 °C

### Long-term drift (per IEC 61298-2)

- ≤ ±0.1 % of span
- ≤ ±0.2 % of span (with special measuring ranges)

### Temperature error (for calibration temperature of 15 ... 25 °C)

For measuring ranges < 1 bar, special measuring ranges and instruments with an increased overpressure limit the respective temperature error increases by 0.5 % of span

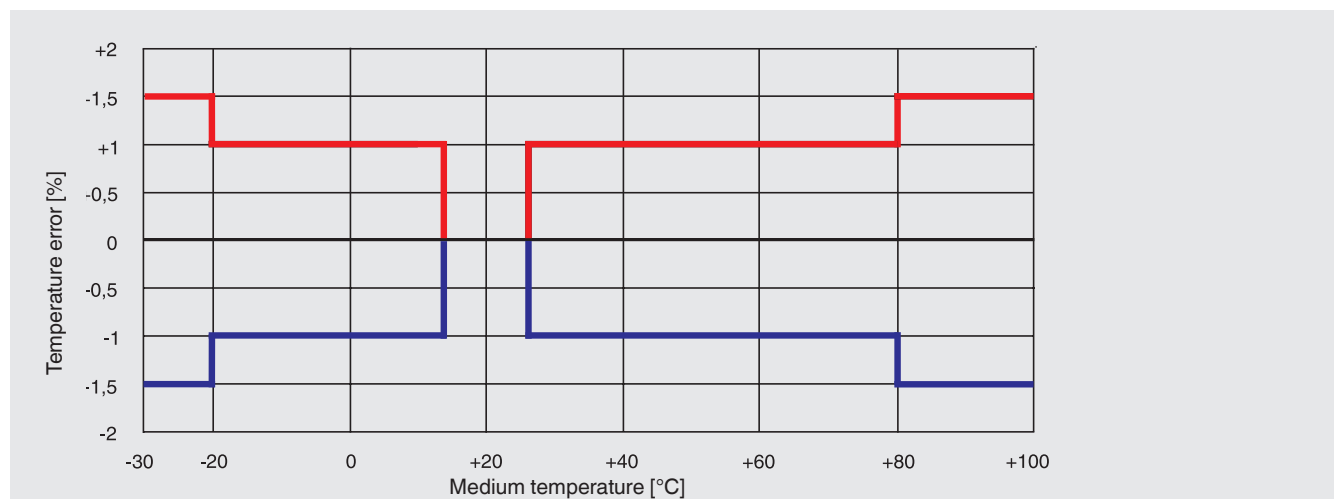

# Operating conditions

## Permissible temperature ranges

Medium	Ambient	Design	maximum permissible pressure
-30 ... +100 °C (standard)	-30 ... +100 °C	-	-
-40 ... +125 °C	-40 ... +125 °C	-	-
-40 ... +150 °C	-40 ... +125 °C 1)	with integrated cooling element	400 bar
-40 ... +200 °C	-40 ... +125 °C 1)	with integrated cooling element	400 bar
-20 ... +60 °C	-20 ... +60 °C	Oxygen applications	-

1) Derating curve and formula (see following diagram)

Depending on the choice of sealing on the process connection and the electrical connection, there may be limitations in the medium and the ambient temperatures.

For restrictions see "Process connections, sealings" and "Electrical connections".

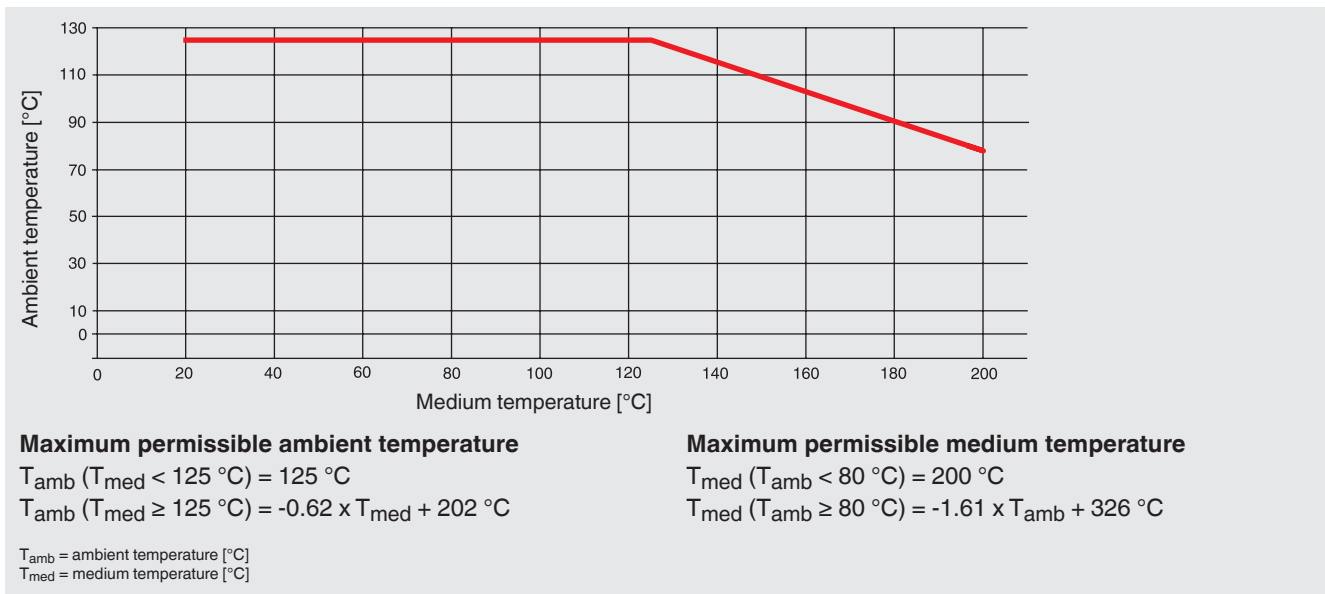

## Storage and transport conditions

- Permissible temperature range: -40 ... +70 °C
- Maximum humidity (per IEC 68-2-78): 67 % r.h. at 40 °C (in accordance with 4K4H per EN 60721-3-4)

## Climate class

- Storage: 1K3 (per EN 60721-3-1)
- Transport: 2K2 (per EN 60721-3-2)
- Operation: 4K4H (per EN 60721-3-4, without condensation or icing)

## Vibration resistance (per IEC 68-2-6)

20 g, 10 ... 2,000 Hz, (40 g, 10 ... 2,000 Hz for heavy-duty connector)

For instruments with cooling elements a limited vibration resistance applies 10 g (10 ... 2,000 Hz)

## Continuous vibration resistance (per IEC 68-2-6)

10 g

## Shock resistance (per IEC 68-2-27)

100 g, 6 ms (500 g, 1 ms for heavy-duty connector)

## Service life

100 million load cycles (10 million load cycles for measuring ranges > 600 bar/7,500 psi)

## Free-fall test (following IEC 60721-3-2)

- Individual packaging: 1.5 m
- Multiple packaging: 0.5 m
- PE bag: 0.5 m

## Process connections

### Available connections

Process connection per	Thread size	Maximum overpressure limit
EN 837	G 1/8 B	800 bar
	G 1/4 B	1,400 bar
	G 1/4 B female	1,400 bar
	G 1/2 B	1,800 bar (1.4404) 3,200 bar (1.4542)
	G 3/8 B	1,400 bar
DIN 3852-E	G 1/4 A	600 bar
	G 1/2 A	600 bar
	M14 x 1.5	600 bar
ISO 228	M20 x 1.5	1,800 bar (1.4404) 3,300 bar (1.4542)
	M12 x 1.5	600 bar
SAE J514 E	7/16-20 UNF BOSS	600 bar
	7/16-20 UNF J514 sealing cone 74°	1,100 bar
	9/16-18 UNF BOSS	600 bar
ANSI/ASME B1.20.1	1/8 NPT	1,100 bar
	1/4 NPT	1,500 bar
	1/4 NPT female	1,500 bar
	1/2 NPT	1,500 bar (1.4404) 2,800 bar (1.4542)
KS	PT 1/4	1,600 bar
	PT 1/2	1,500 bar
	PT 3/8	1,400 bar
ISO 7	R 1/4	1,600 bar
	R 3/8	1,500 bar
	R 1/2	1,400 bar (1.4404) 2,840 bar (1.4542)

Other process connections on request.

### Pressure channel

Pressure channel diameter	Possible for thread sizes
<b>2.5 mm (standard)</b>	<b>all thread sizes</b>
0.3 mm	G 1/4 A, G 1/2 A, 1/4 NPT, 1/2 NPT, R 1/4, 7/16-20 UNF BOSS
0.6 mm	G 1/4 A, G 1/2 A, 1/4 NPT, 1/2 NPT, R 1/4, 7/16-20 UNF BOSS
6 mm	G 1/4 A, 1/4 NPT, R 1/4, 7/16-20 UNF BOSS
12 mm	G 1/2 A, 1/2 NPT

Widened pressure channel with 6 or 12 mm, only feasible for measuring ranges up to and including 0 ... 40 bar or 0 ... 500 psi.

### Sealings

Process connection per	Copper -40 ... +125 °C	Stainless steel -40 ... +125 °C	NBR -20 ... +100 °C	FKM -15 ... +125 °C
EN 837	Standard	Option	-	-
DIN 3852-E	-	-	Standard	Option
ISO 228	Standard	Option	-	-
SAE J514 E	-	-	Standard	Option

## Electrical connections

### Available connections

Electrical connection	Ingress protection	Wire cross-section	Cable Ø	Cable material	maximum permissible temperature
Angular connector DIN 175301-803 A <sup>1)</sup>	IP 65	-	-	-	-30 ... +100 °C
Angular connector DIN 175301-803 C <sup>1)</sup>	IP 65	-	-	-	-30 ... +100 °C
Circular connector M12 x 1 (4-pin) <sup>1)</sup>	IP 67	-	-	-	-30 ... +100 °C
Circular connector M12 x 1 (4-pin, metallic)	IP 67	-	-	-	-40 ... +125 °C (cULus: +85 °C)
Bayonet connector (6-pin)	IP 67	-	-	-	-40 ... +125 °C
Field case	IP 6K9K	-	-	-	-25 ... +100 °C
Heavy-duty connector <sup>2)</sup>	IP 68	-	-	-	-40 ... +125 °C
Cable outlet IP 67 <sup>1)</sup>	IP 67	3 x 0.34 mm <sup>2</sup>	5.5 mm	PUR	-30 ... +100 °C
Cable outlet ½ NPT conduit	IP 67	6 x 0.35 mm <sup>2</sup>	6.1 mm	PUR	-30 ... +100 °C (cULus: +90 °C)
Cable outlet IP 68	IP 68	6 x 0.35 mm <sup>2</sup>	6.1 mm	PUR	-30 ... +125 °C (cULus: +90 °C)
Cable outlet IP 68, FEP	IP 68	6 x 0.39 mm <sup>2</sup>	5.8 mm	FEP	-40 ... +125 °C (cULus: +105 °C)
Cable outlet IP 6K9K	IP 6K9K	6 x 0.35 mm <sup>2</sup>	6.1 mm	PUR	-30 ... +125 °C (cULus: +90 °C)

1) Customer zero point adjustment available as an option.

2) max. DC 32 V with cULus approval

Other connections on request.

### Assembly configurations of the mating connectors

Mating connector for electrical connection	Ingress protection	Wire cross-section	Cable Ø	Cable material	max. permissible temperature	Cable ends
<b>Angular connector DIN 175301-803 A</b>						
■ Mating connector	IP 65	max. 1.5 mm <sup>2</sup>	6 ... 8 mm	-	-40 ... +125 °C	-
■ Mating connector (conduit)	IP 65	max. 1.5 mm <sup>2</sup>	-	-	-40 ... +125 °C	-
■ Mating connector with moulded cable	IP 65	3 x 0.75 mm <sup>2</sup>	6 mm	PUR	-40 ... +125 °C (cULus: -25 ... +85 °C)	no finishing
■ Mating connector with moulded cable, shielded	IP 65	6 x 0.5 mm <sup>2</sup>	6.8 mm	PUR	-25 ... +85 °C	End splices
<b>Angular connector DIN 175301-803 C</b>						
■ Mating connector	IP 65	max. 0.75 mm <sup>2</sup>	4.5 ... 6 mm	-	-40 ... +125 °C	-
■ Mating connector with moulded cable	IP 65	4 x 0.75 mm <sup>2</sup>	5.9 mm	PUR	-25 ... +85 °C	no finishing
<b>Circular connector M12 x 1 (4-pin)</b>						
■ Mating connector, straight, with moulded cable	IP 67	3 x 0.34 mm <sup>2</sup>	4.3 mm	PUR	-25 ... +80 °C	no finishing
■ Straight mating connector, with moulded cable, shielded	IP 67	3 x 0.34 mm <sup>2</sup>	4.3 mm	PUR	-25 ... +80 °C	no finishing
■ Mating connector, angled, with moulded cable	IP 67	3 x 0.34 mm <sup>2</sup>	5.5 mm	PUR	-25 ... +80 °C	no finishing
<b>Heavy-duty connector</b>						
■ Mating connector with cable	IP 68	6 x 0.14 mm <sup>2</sup>	6.5 mm	PUR	-40 ... +125 °C (cULus: -30 ... +90 °C)	no finishing

### Assembly configurations of the cable outlets

Electrical connection	Unfinished wire ends	Tinned wire ends	with end splices
Cable outlet IP 67	Standard	Option	Option
Cable outlet ½ NPT conduit	-	Option	Standard
Cable outlet IP 68	-	Option	Standard
Cable outlet IP 68, FEP	-	Option	Standard
Cable outlet IP 6K9K	-	Option	Standard

Cable lengths of 2 m, 5 m, 6 ft or 15 ft are available, further cable lengths on request.



## Connection diagrams

Angular connector DIN 175301-803 A			
		2-wire	3-wire
	U+	1	1
	U-	2	2
	S+	-	3
	Shield (option)	4	4

Heavy-duty connector			
		2-wire	3-wire
	U+	1	1
	U-	2	2
	S+	-	3
	Shield	Case	Case

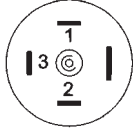
Angular connector DIN 175301-803 C			
		2-wire	3-wire
	U+	1	1
	U-	2	2
	S+	-	3
	Shield (option)	4	4

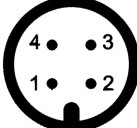
Circular connector M12 x 1 (4-pin)			
		2-wire	3-wire
	U+	1	1
	U-	3	3
	S+	-	4
	Shield (option)	Case	Case

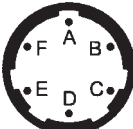
Bayonet connector (6-pin)			
		2-wire	3-wire
	U+	A	A
	U-	B	B
	S+	-	C
	Shield	Case	Case

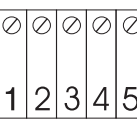
Field case			
		2-wire	3-wire
	U+	1	1
	U-	2	2
	S+	-	3
	Shield	5	5

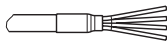
Cable outlet incl. mating connector with moulded cable			
		2-wire	3-wire
	U+	brown (BN)	brown (BN)
	U-	blue (BU)	blue (BU)
	S+	-	black (BK)
	Shield	grey (GY)	grey (GY)

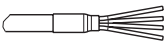
Cable outlet (US code)			
		2-wire	3-wire
	U+	red (RD)	red (RD)
	U-	black (BK)	black (BK)
	S+	-	white (WH)
	Shield	grey (GY)	grey (GY)

Other pin assignments on request.

## Electrical protective measures

The electrical protective measures are not valid for ratiometric output signals.

- Short-circuit resistance: S+ vs. U-
- Reverse polarity protection: U+ vs. U-
- Resistance to overvoltage: DC 40 V
- Insulation voltage: DC 750 V

## Materials

### Wetted parts

- Relative measuring ranges:
  - Measuring ranges  $\leq$  10 bar/150 psi: 316L
  - Measuring ranges  $>$  10 bar/150 psi: 316L + 13-8 PH
- Absolute pressure measuring ranges:
  - Measuring ranges  $\leq$  1,000 bar/10,000 psi: ASTM 630 and 13-8 PH
  - Measuring ranges  $>$  1,000 bar/10,000 psi: 316L + 13-8 PH
- Sealing materials: see "Process connections"

### Non-wetted parts

- Case: 316 Ti
- Zero point adjustment ring: PBT/PET GF30
- Electrical connections:
  - Angular connector DIN 175301-803 A: PBT/PET GF30
  - Angular connector DIN 175301-803 C: PBT/PET GF30
  - Circular connector M12 x 1 (4-pin): PBT/PET GF30
  - Circular connector M12 x 1 (4-pin, metallic): 316L
  - Bayonet connector (6-pin): 316L + Al
  - Field case: 316L, 316Ti
  - Heavy-duty connector: 316L
  - Cable outlet IP 67: PA66
  - Cable outlet 1/2 NPT conduit: 316L
  - Cable outlet IP 68: 316L
  - Cable outlet IP 68, FEP: 316L
  - Cable outlet IP 6K9K: 316L

### Pressure transmission fluid

Synthetic oil (for measuring ranges  $<$  10 bar/150 psi relative and absolute pressure)

### Options for specific media

Medium	Option
Food	Food-compatible transmission fluid
Oil and grease free	Residual hydrocarbon: $<$ 1,000 mg/m <sup>2</sup> Packaging: Protection cap on the process connection
Oxygen, oil and grease free	Residual hydrocarbon (measuring range $<$ 30 bar): $<$ 500 mg/m <sup>2</sup> Residual hydrocarbon (measuring range $>$ 30 bar): $<$ 200 mg/m <sup>2</sup> Packaging: Protection cap on the process connection, instrument sealed in a PE bag Maximum permissible temperature -20 ... +60 °C  Elastomer sealing: oly FKM possible, max. -15 ... +60 °C and max. 30 bar measuring range.  Not possible with process connections with female thread
Hydrogen	<b>On request</b> Measuring ranges: from 25 bar relative Wetted parts: 316L and Elgiloy® (2.4711) Maximum permissible temperature: -30 ... +30 °C

## CE conformity

### Pressure equipment directive

97/23/EC

### EMC directive

2004/108/EC, EN 61326 emission (group 1, class B) and interference immunity (industrial application)

### EM field

30 V/m (80 ... 1,000 Mhz)

### RoHS conformity

Directive 2002/95/EC

### Performance level (per EN ISO 13849-1:2008)

- Performance level: PL = C
- Category: Cat. = 1
- Diagnostic coverage: DC = none
- MTTF: > 100 years

## Certificates (option)

Available certificates	
2.2 test report	State-of-the-art manufacturing Wetted metallic parts Confirmation of the class and indication accuracy
3.1 inspection certificate	Wetted metallic parts Wetted metallic parts with suppliers' certificate Confirmation of the class and indication accuracy List of single measured values
DKD/DAkkS calibration certificate	

Certificates, see website

## Scope of delivery

### Test report

- Non-linearity 0.5 % 3 points
- Non-linearity 0.25 % 5 points
- Non-linearity 0.125 % 5 points

### Packaging

#### Individual packaging (standard)

Multiple packaging (up to 20 pieces)

### Instrument labelling

#### WIKA label lasered (standard)

Customer-specific label on request

# Dimensions in mm

## Pressure transmitter model S-20

with angular connector DIN 175301-803 A

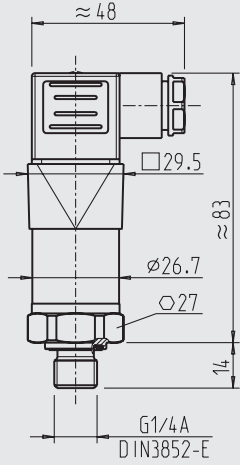

Weight: approx. 150 g

with angular connector DIN 175301-803 C

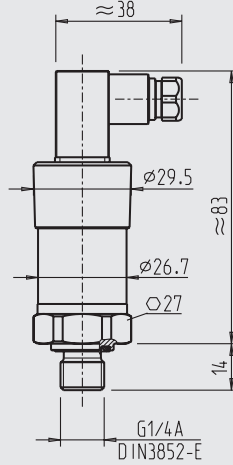

Weight: approx. 150 g

with bayonet connector (6-pin)

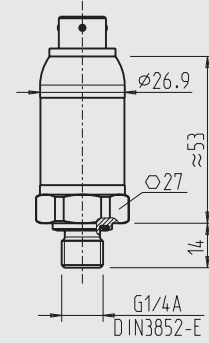

Weight: approx. 150 g

with circular connector M12 x 1 (4-pin)

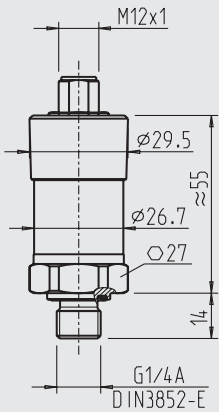

Weight: approx. 150 g

with circular connector M12 x 1 (4-pin, metallic)

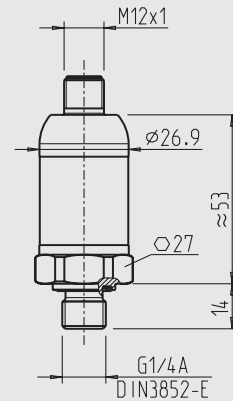

Weight: approx. 150 g

with heavy-duty connector

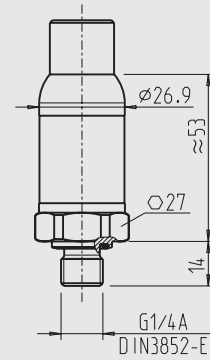

Weight: approx. 150 g

with field case

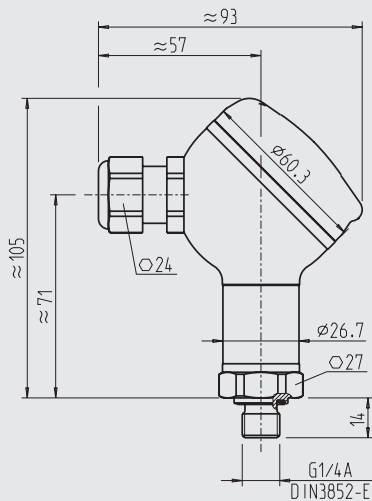

Weight: approx. 290 g

with cable outlet IP 68, FEP, IP 6K9K

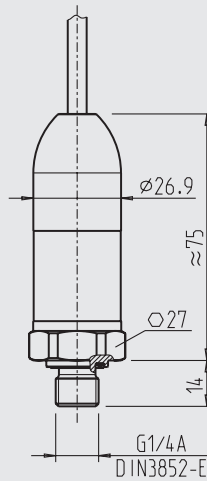

Weight: approx. 220 g

with cable outlet 1/2 NPT conduit

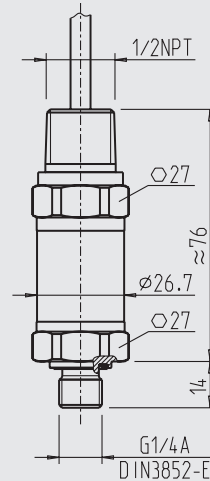

Weight: approx. 220 g

with angular connector DIN 175301-803 A  
and cooling element

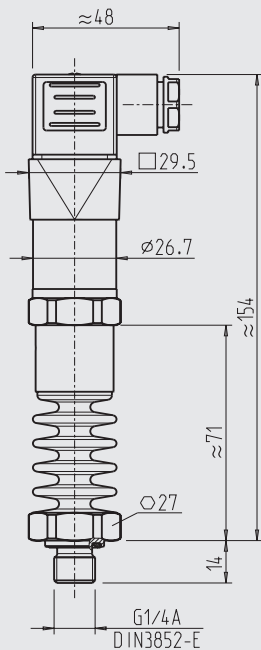

Weight: approx. 360 g

with cable outlet IP 67

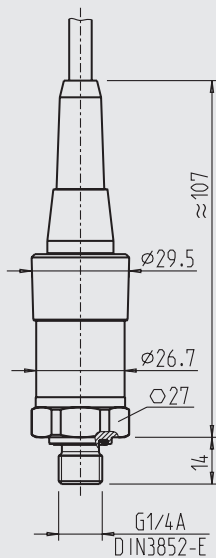

Weight: approx. 150 g

with angular connector DIN 175301-803 A  
and zero point adjustment

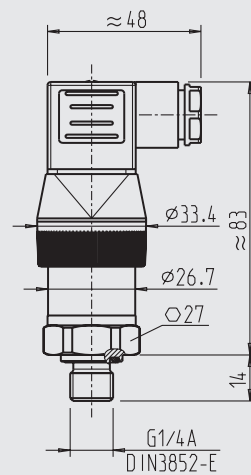

Weight: approx. 150 g

## Process connections

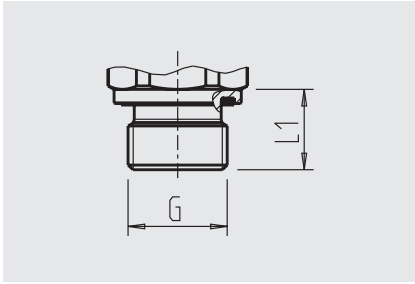

G	L1
G ¼ A	14
G ½ A	17
M14 x 1.5	14

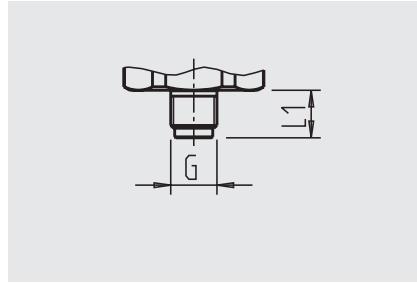

G	L1
G ⅛ B	10

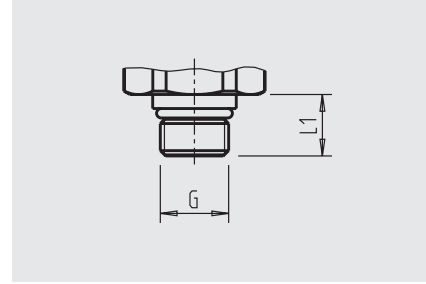

G	L1
7/16-20 UNF BOSS	12.06
9/16-18 UNF BOSS	12.85

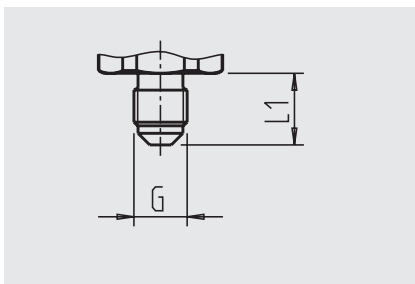

G	L1
7/16-20 UNF J514 sealing cone 74°	15

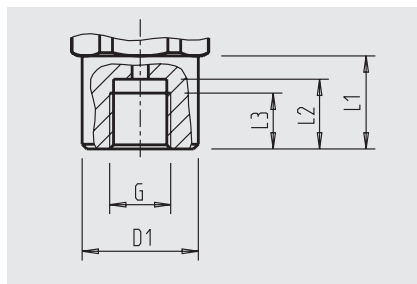

G	D1	L1	L2	L3
G ¼ B female	25	20	13	10

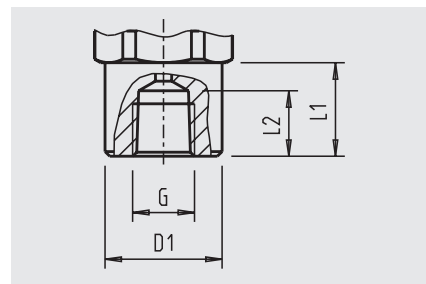

G	D1	L1	L2
¼ NPT female	25	20	14

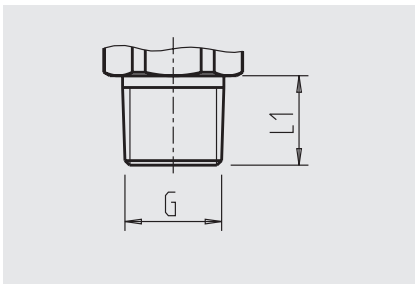

G	L1
⅛ NPT	10
¼ NPT	13
½ NPT	19
PT ¼	13
PT ½	19
PT ¾	15
R ¼	13
R ½	19
R ¾	15

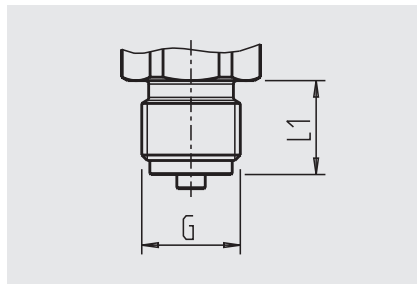

G	L1
G ¼ B	13
G ½ B	20
G ¾ B	16
M12 x 1.5	15
M20 x 1.5	20

For information on tapped holes and welding sockets, see Technical information IN 00.14 at [www.wika.com](http://www.wika.com).

## Accessories and spare parts

### Mating connector

Designation	Order number			
	without cable	with 2 m cable	with 5 m cable	with 2 m cable, shielded
<b>Angular connector DIN 175301-803 A</b>				
■ with gland, metric	11427567	11225793	11250186	2242656
■ with gland, conduit	11022485	-	-	-
<b>Angular connector DIN 175301-803 C</b>	1439081	11225823	11250194	-
<b>Circular connector M12 x 1 (4-pin)</b>				
■ straight	-	11250780	11250259	14056584
■ angled	-	11250798	11250232	-

### Sealings for mating connectors

Mating connector	Order number	
	Blue (WIKA)	Brown (neutral)
Angular connector DIN 175301-803 A	1576240	11437902
Angular connector DIN 175301-803 C	11169479	11437881

### Sealings for process connection

Thread size	Order number			
	Copper	Stainless steel	NBR	FKM
G 1/8 B	11251051	-	-	-
G 1/4 B	11250810	11250844	-	-
G 1/2 B	11250861	11251042	-	-
G 3/8 B	14065101	-	-	-
M12 x 1.5	11250810	11250844	-	-
M20 x 1.5	11250861	11251042	-	-
G 1/4 A	-	-	1537857	1576534
G 1/2 A	-	-	1039067	1039075
M14 x 1.5	-	-	1537857	1576534
7/16-20 UNF BOSS	-	-	14057554	11472022
9/16-18 UNF BOSS	-	-	14057555	2063240

### Ordering information

Model / Measuring range / Overpressure limit / Output signal / Non-linearity / Calibration temperature / Zero point adjustment / Process connection / Pressure channel / Sealing / Electrical connection / Assembly / Cable length / Shielding / Certificates / Packaging / Instrument labelling / Accessories and spare parts

© 2013 WIKA Alexander Wiegand SE & Co. KG, all rights reserved.  
The specifications given in this document represent the state of engineering at the time of publishing.  
We reserve the right to make modifications to the specifications and materials.

